

Kabelabdeckhaube

Draufsicht

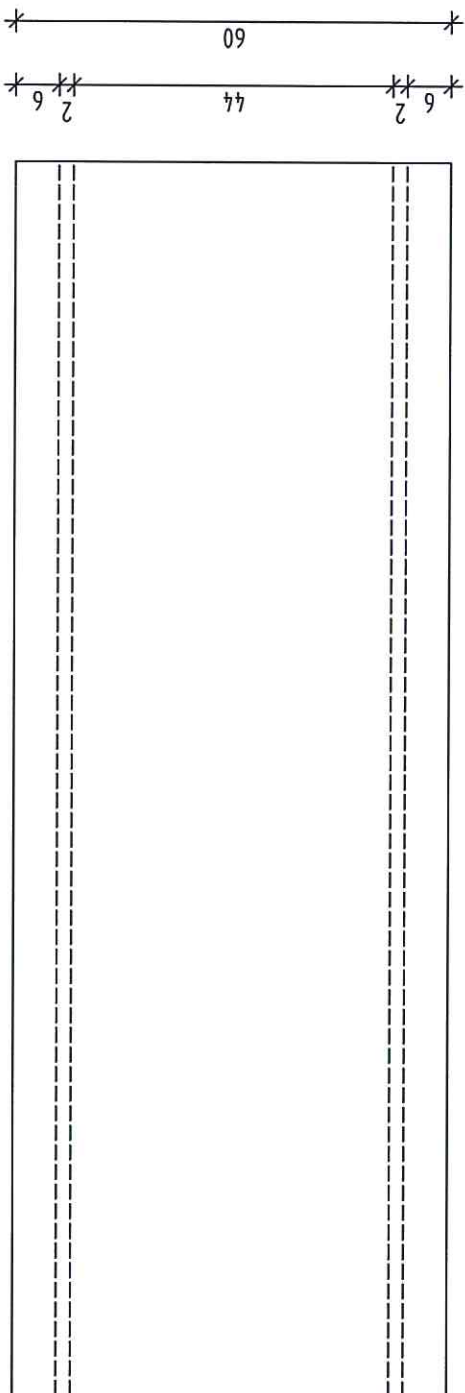

1.70

Seitenansicht

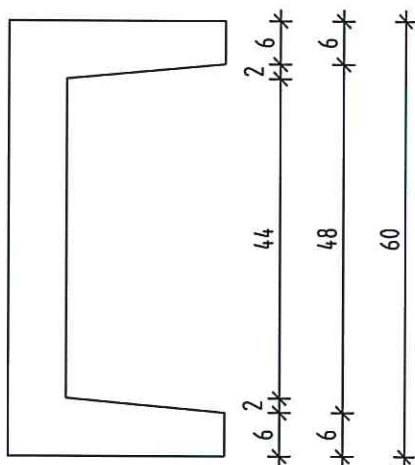

22
8

30

Isometrie
(unmaßstäblich)

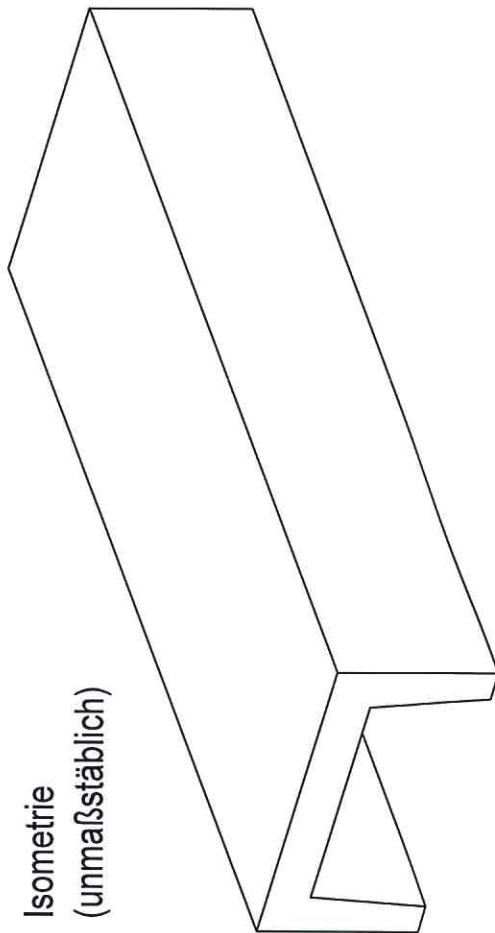

Maßstab 1:10

Sturz mit Kragplatte

Ansicht

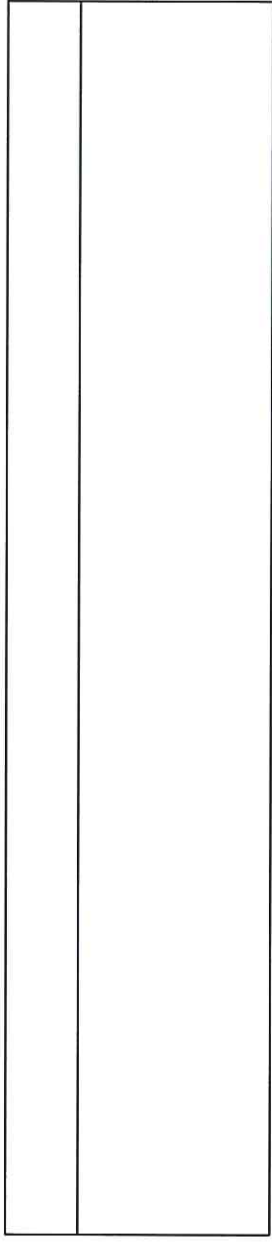

1.70

Seitenansicht

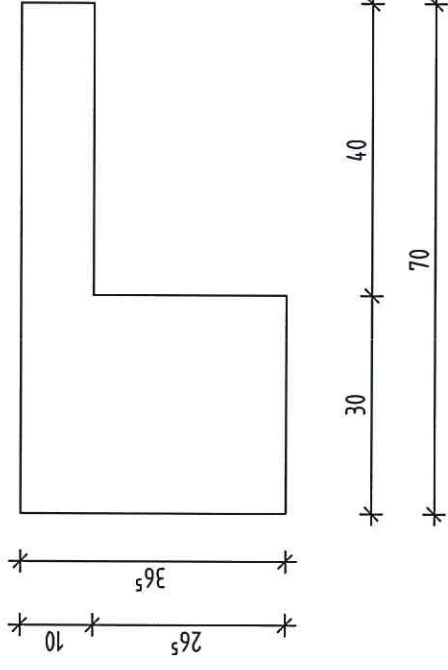

Draufsicht

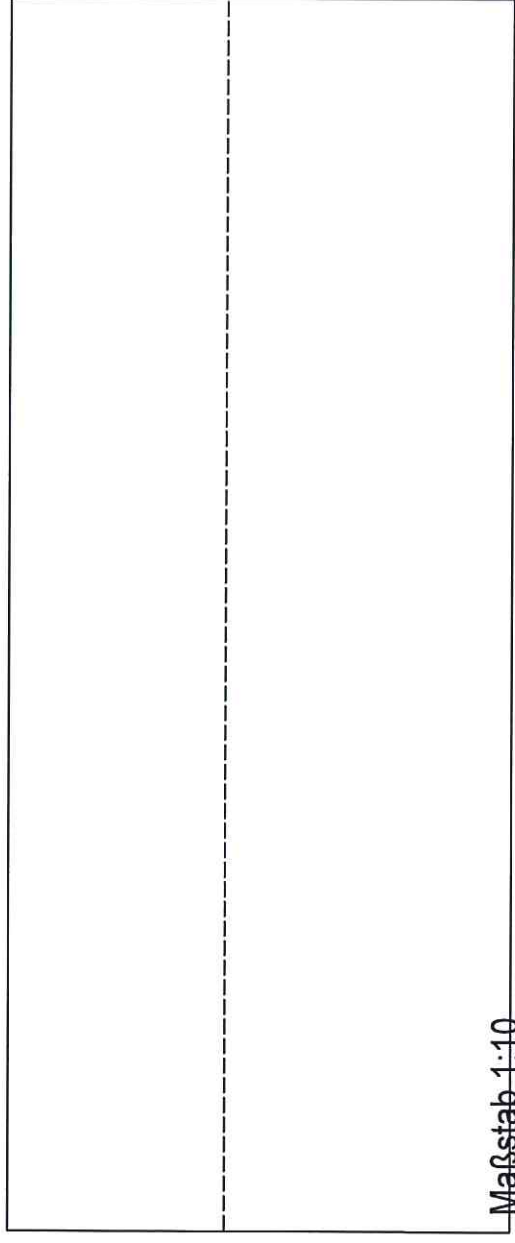

Maßstab 1:10

Isometrie
(unmaßstäblich)

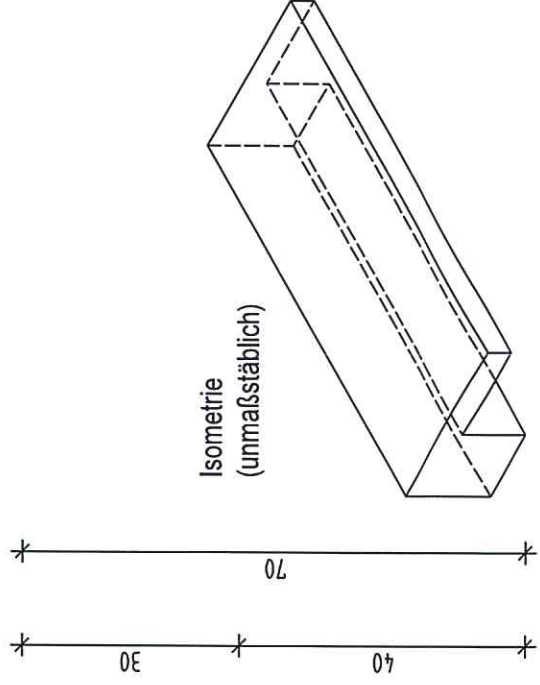

Betonpfosten

Ansicht

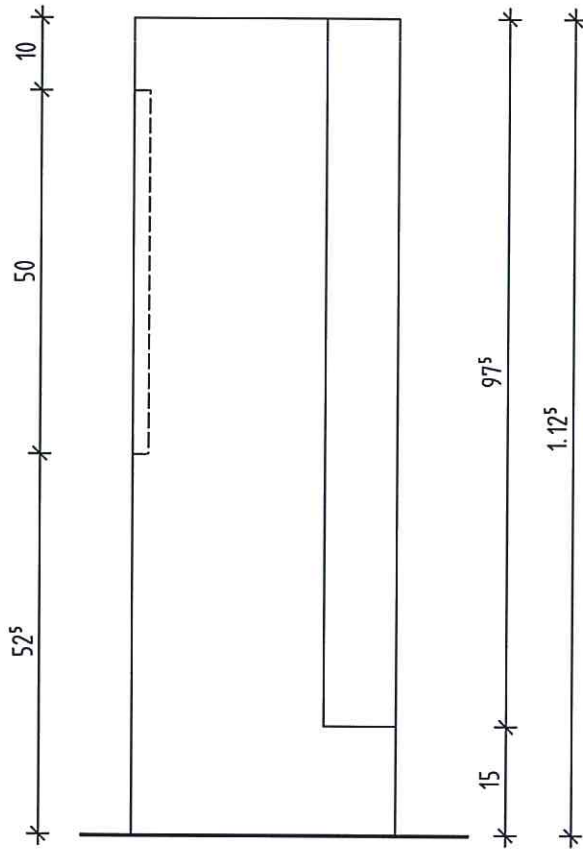

Seitenansicht (von rechts)

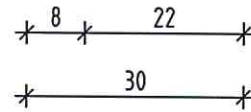
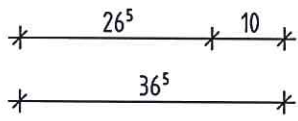
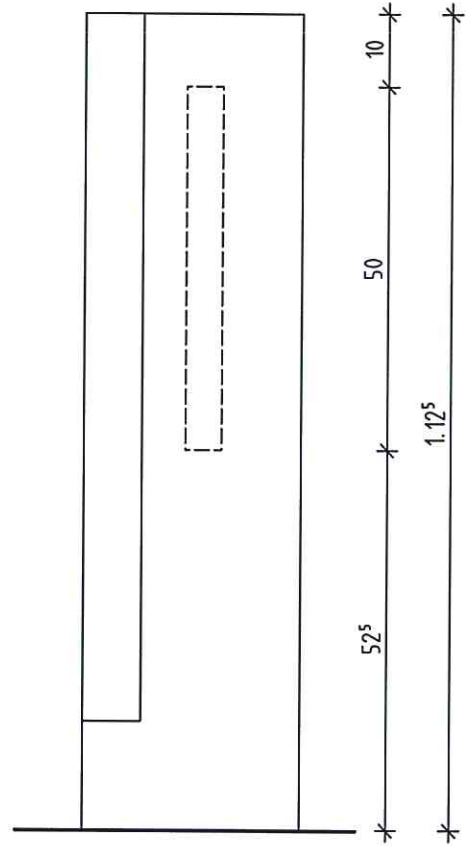

Draufsicht

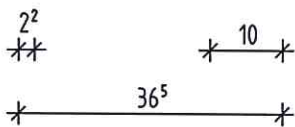
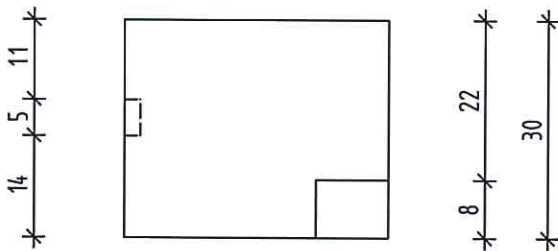

Maßstab 1:10

Podestplatte

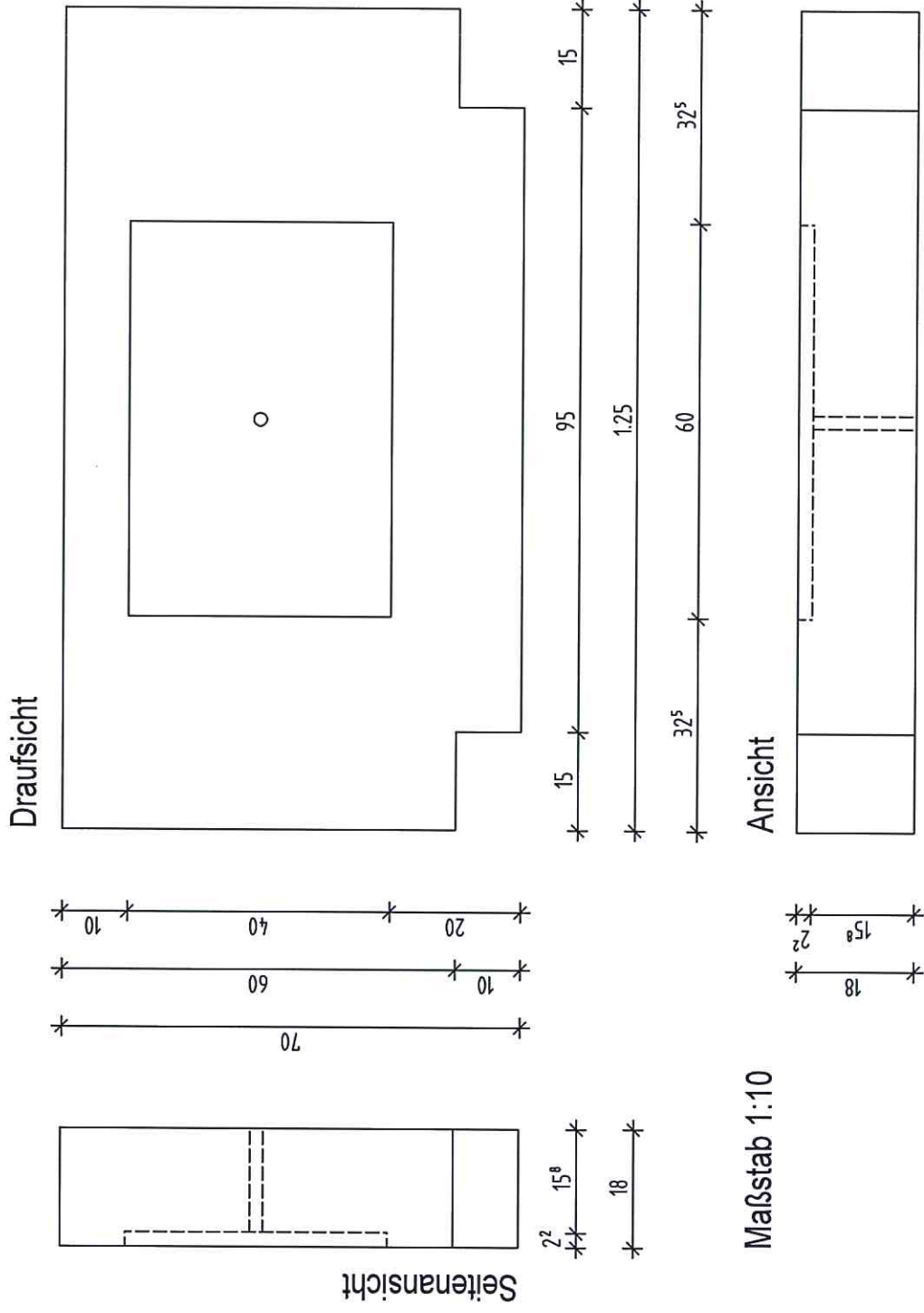

Maßstab 1:10

Kontrollschacht 60 / 60 mit Falz und Aussparungen

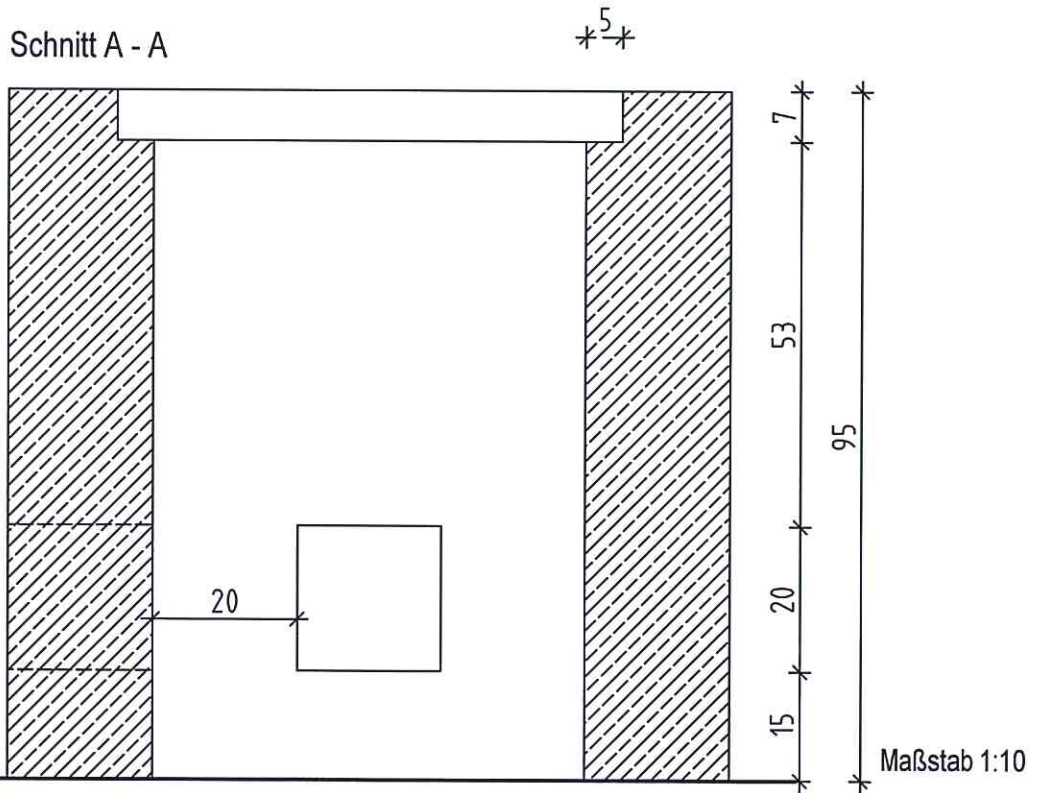
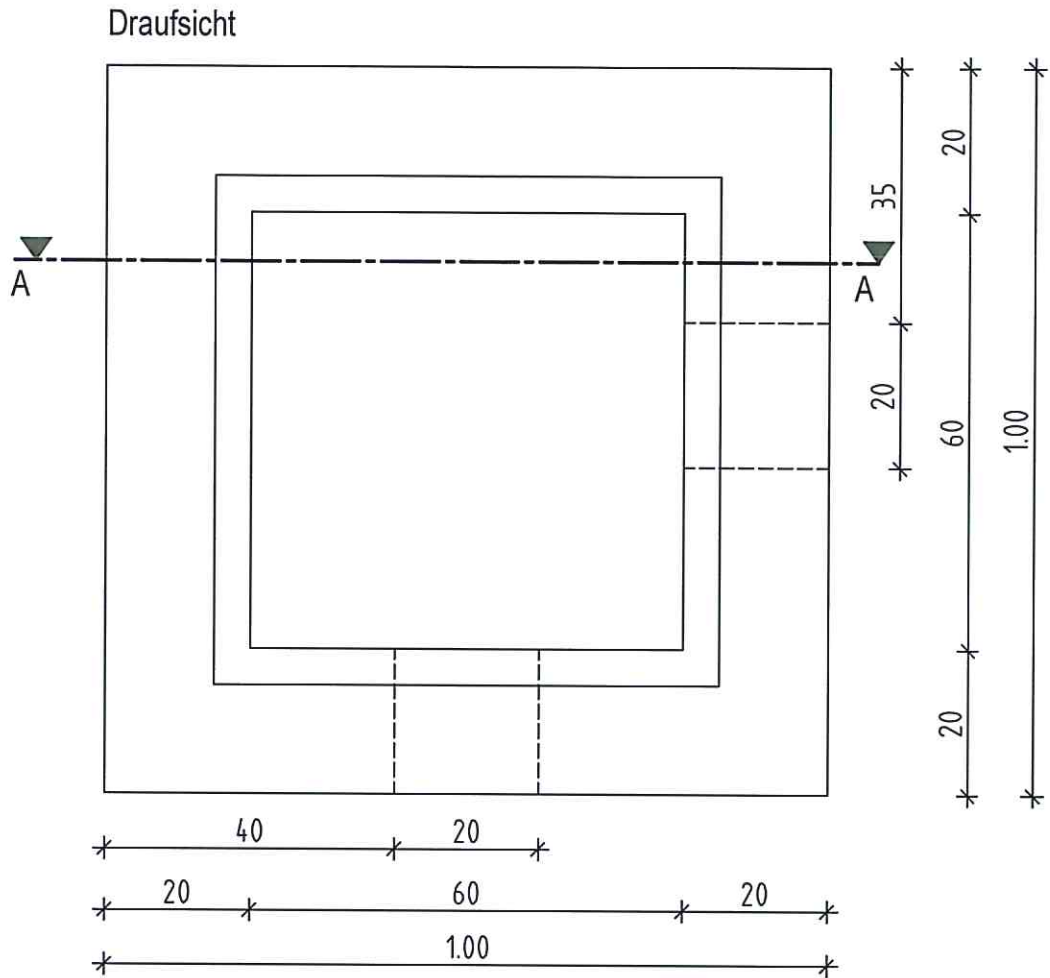

Kontrollschacht

Isometrie

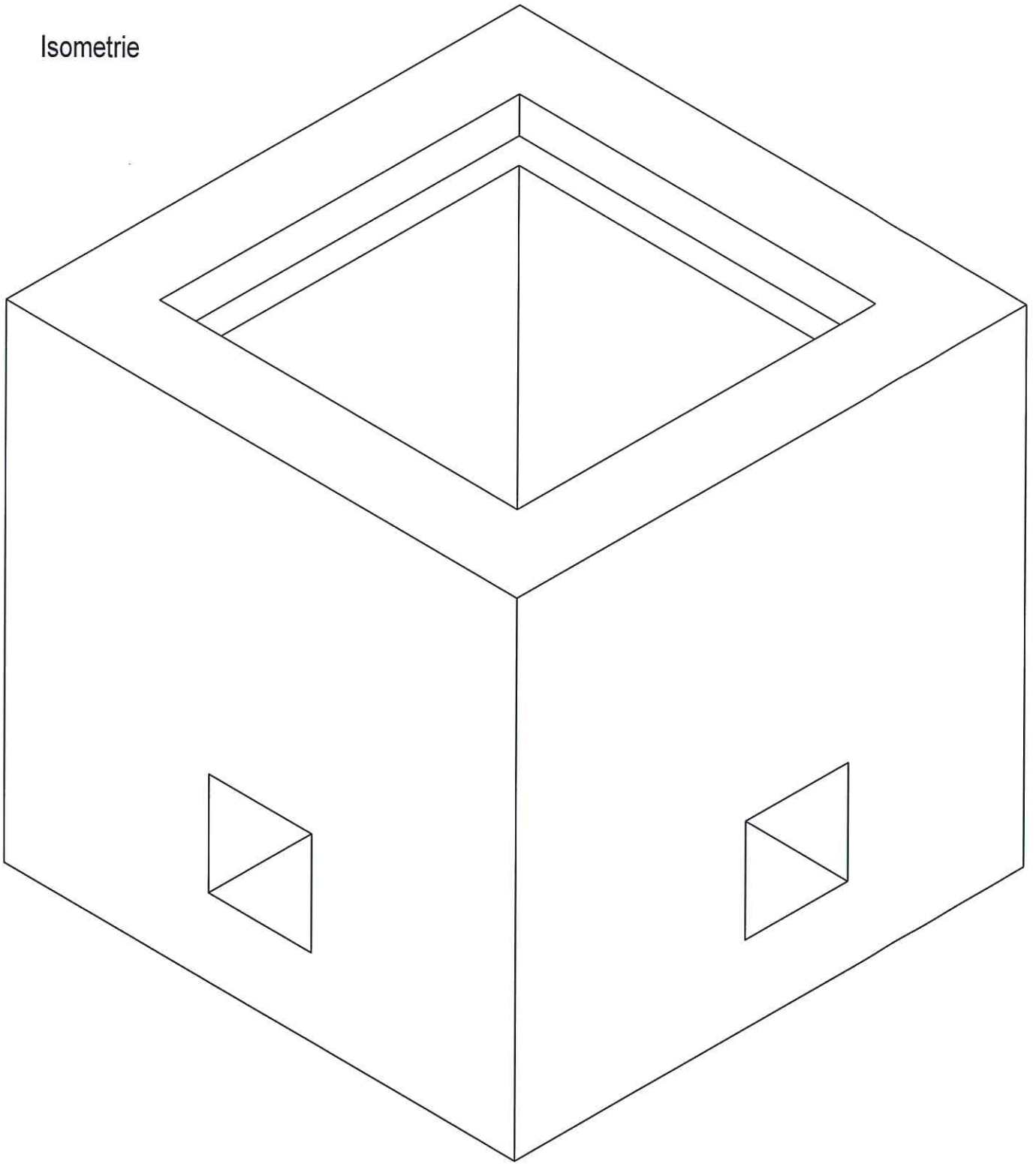

Rampentreppe

Draufsicht

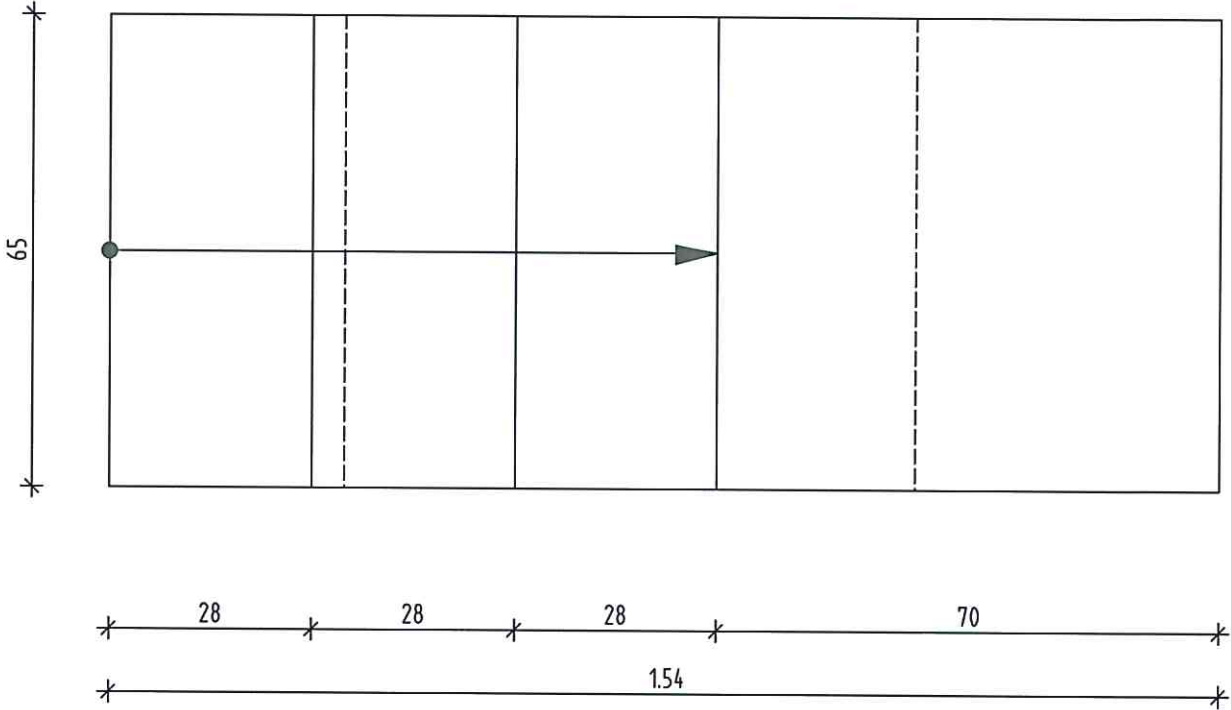

Seitenansicht

